

Valberg 4 Tier

PRODUCT DESCRIPTION

The **Valberg** Circular pendant is made of extruded aluminum with direct and indirect components and glare free, non yellowing acrylic diffuser rings. Sizes range from 16" to 144" and can be combined as desired to create multiple ring masterpieces. Tunable white and RGBW. Over 6500 powder coated colors, ships assembled up to 72" diameter. resistant against yellowing, height adjustable, offering over 6,500 custom powder coated colors, ships Assembled.

FEATURES

- 5-year limited warranty.
- Ships assembled.
- Direct and Indirect Illumination.
- Extruded aluminum housing up to 72", 1 continuous ring without joints.
- Fixture lumens per watt ratio 70 LPW-87 LPW.

SPECIFICATIONS

- 90+ CRI.
- Input: 100-277V, 50/60Hz.
- 1-10V dimming standard, ELV / TRIAC dimming available.
- UL listed, suitable for dry location.
- Gloss White, Black Jack, Platinum Silver and Oil bronze color finish as standard, 6,500 custom colors are available.
- Built in color temperature selectable. Choose from 3000K/3500K/4000K. Custom color temperatures. lumen outputs, RGBW, Tunable White available.

PARTS PACKED WITH STANDARD FIXTURE

- Plastic Anchors, Screws, Wire Connectors
- CCT Selector Switch



SB-U03F



SB-U03G

MODEL INFORMATION:

Example: SB-U03F90WSB

Products Series	Wattage/Size	Options	RGBW/CCT Select Only	Profile Finishes	Aircraft Cable
*SB-U03F SB-U03G	110W = 32" + 24" + 32" 140W = 40" + 32" + 40" 170W = 48" + 40" + 48" 200W = 60" + 48" + 60" 230W = 72" + 60" + 72"	*S=1-10V dimming, CRI 90 3000K/3500K/4000K Color Selectable (Standard), 4000K factory color default set	T=3K-4K Tunable White	*B=Black Jack	*Blank=10' foot 120" (Standard)
		L=ELV/Triac dimming with 3000K/3500K/4000K Color Selectable	R4=RGB+4000K (standard)	S=Platinum Silver	5'=5 foot 60"
		D=DMX	R3=RGB+3000K	W=Gloss White	15'=15 foot 180"
		Z=ZigBee		O=Oil Rubbed Bronze	20'=20 foot 240"
		DMX for RGBW and Tunable White, control by Wall Switch or DMX control system.	Do not select this column if selected "S"	Full Color Name or RAL number for Custom Colors, select from Color Collections	
		ZigBee for RGBW and CCT tunable / dimmable using remote, DMX, App and Google Alexa.			

LUMEN OUTPUT

Model Number	Size	Wattage	Kevin	Lumen
SB-U03F/G	32" + 24" + 32"	110W	3000K/3500K/4000K	7778 lm
	40" + 32" + 40"	140W	3000K/3500K/4000K	10035 lm
	48" + 40" + 48"	170W	3000K/3500K/4000K	13164 lm
	60" + 48" + 60"	200W	3000K/3500K/4000K	15501 lm
	72" + 60" + 72"	230W	3000K/3500K/4000K	19361 lm

STANDARD COLOR FINISHES



In addition to our standard colors, we offer more than 6,500 [finishes and colors](#) for your luminaire. We can match your paint sample or any RAL finish. Add texture and originality to create a perfect match.

EMERGENCY BATTERY OPTIONS

[SEE SPEC](#)

PICTURE	MODEL NUMBER	DESCRIPTION
	SB-EBP/5W/B	Factory installed Remote Emergency Battery Pack 5W 90 minutes
	SB-EBP/10.7W/B	Factory installed Remote Emergency Battery Pack 10.7W 90 minutes
	SB-EBP/17W/B	Factory installed Remote Emergency Battery Pack 17W 90 minutes

RGBW/TUNABLE WHITE SMART CONTROL

[SEE SPEC AND VIDEO](#)

Get Smart

Using Amazon Echo, Echo Dot, or any Alexa-enabled device allows you to turn your luminaire on and off, dim the light and change light color to Red, Green, Blue or White independently by using voice command or Smart phone app, DMX, Handheld remote or wall control.

DIMENSIONS & WEIGHTS: Canopy Size for ZigBee & DMX: 15.75" x 2.76"

23.62" = 24" / 31.5" = 32" / 39.37" = 40" / 47.24" = 48" / 59.06" = 60" / 70.87" = 72"

SB-U03F/G

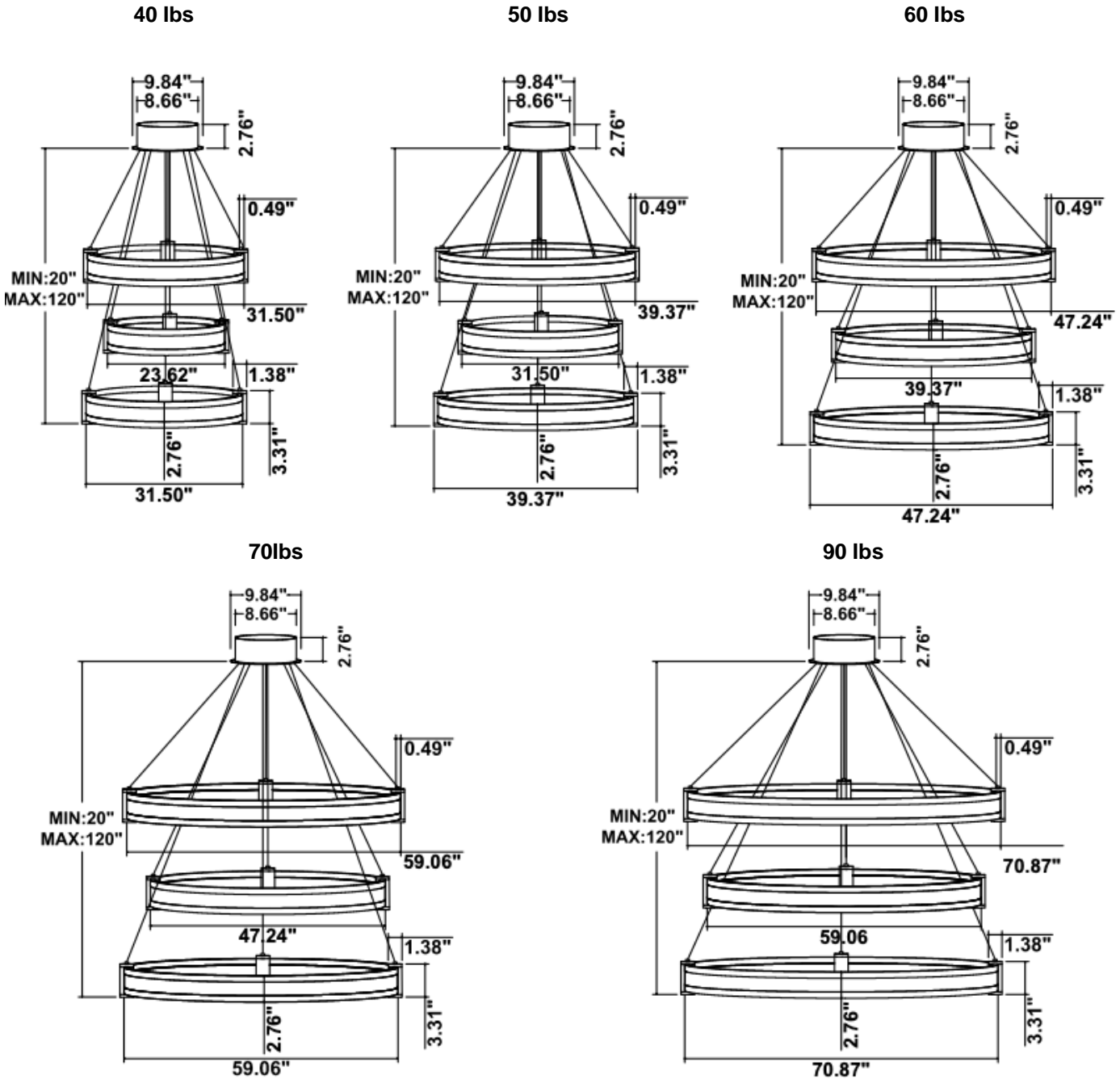

PHOTOMETRIC: Single ring test report

SB-U01A30WSZ 24" 30W @ 4000K

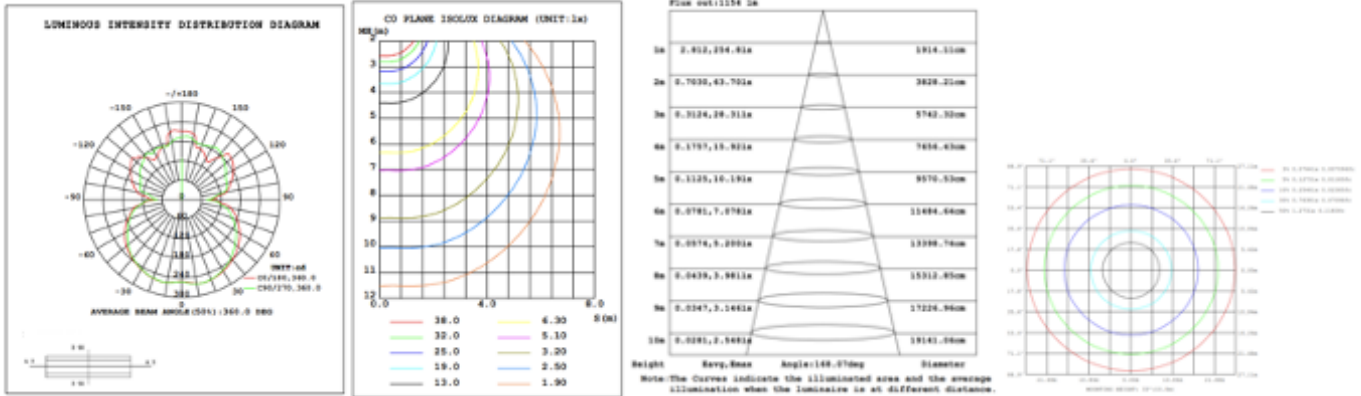

SB-U01A40WSZ 32" 40W @ 4000K

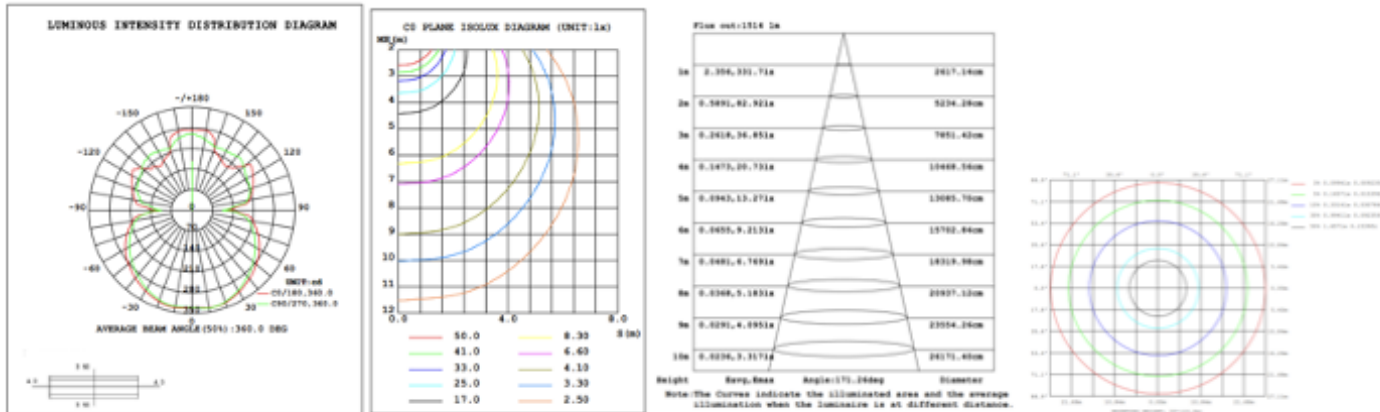

SB-U01A50WSZ 40" 50W @ 4000K

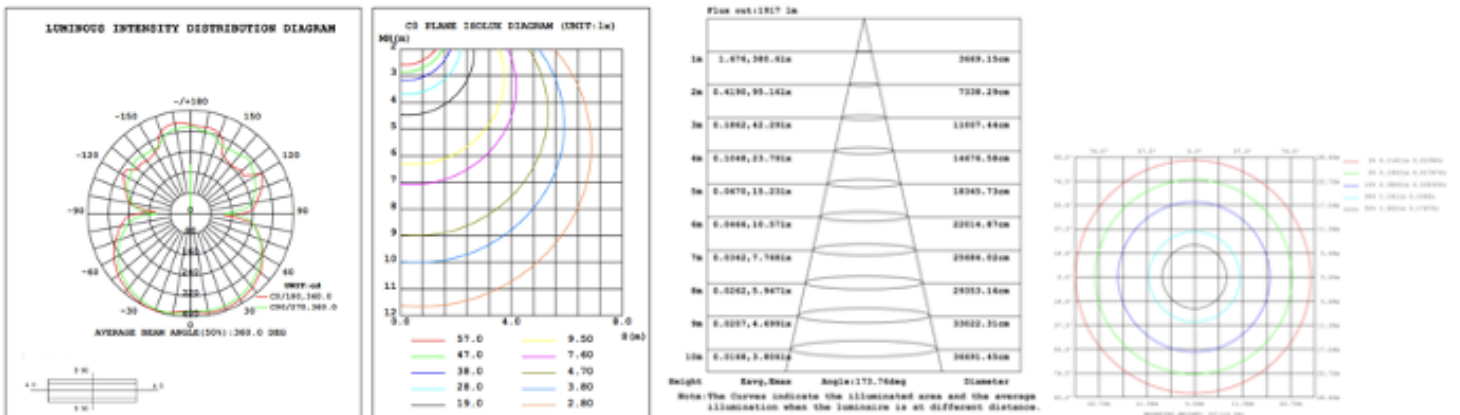

SB-U01A60WSZ 48" 60W @ 4000K

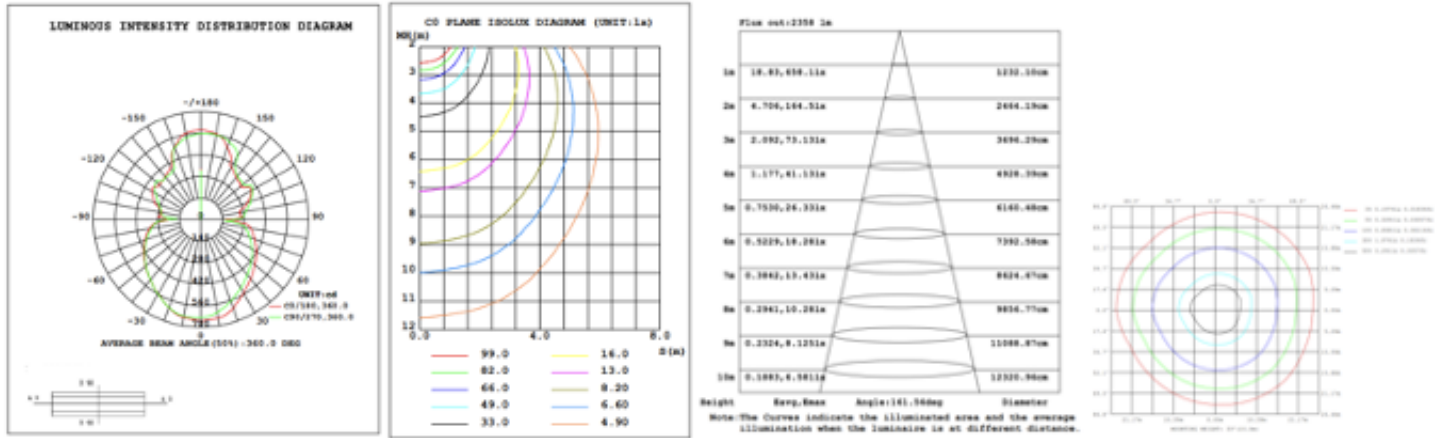

SB-U01A70WSZ 60" 70W @ 4000K

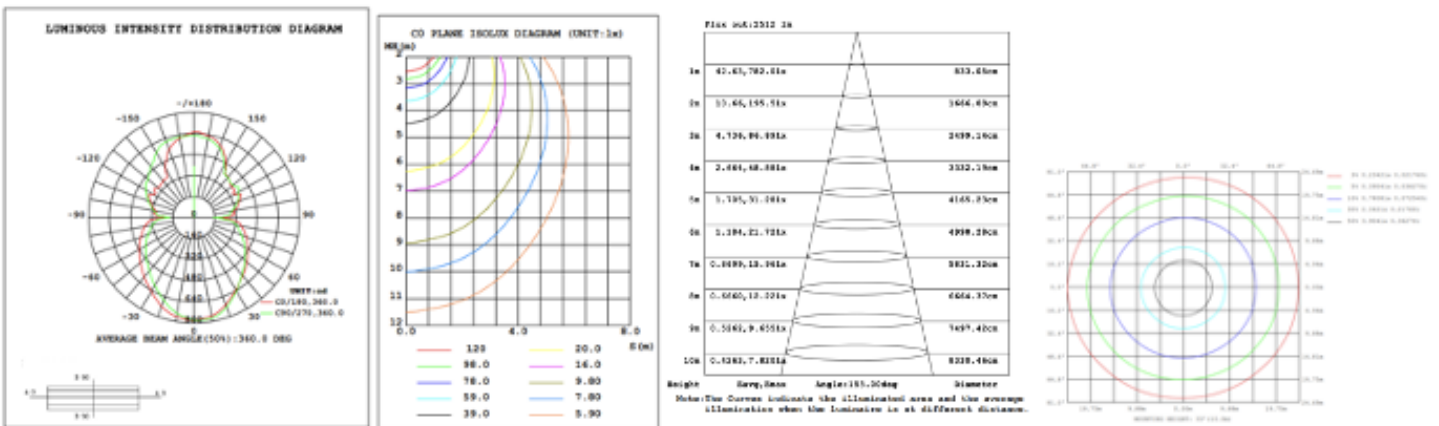

SB-U01A80WSZ 72" 80W @ 4000K

